

Data Sheet



Article number: 5863501812

Description: Ball Valve 350.1812, G 1" - G 1"
Thread/Thread

Measures

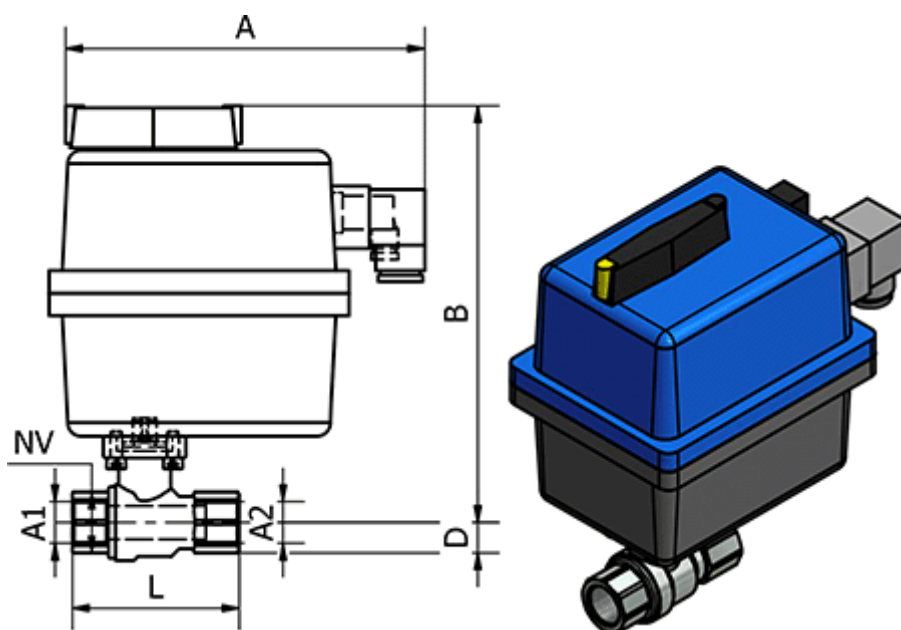

= -	D	= 25
= -	L	= 90
= -	Max. Operating Pressure	= 40 bar
= -	NV	= 41

A = 177
B = 214
Connecting A1 = G 1"
Connecting A2 = G 1"